



# SAUSAGE STUFFERS

## EUROPEAN SAUSAGE STUFFERS

Item #:

13730/ 40517/ 13732/ 13733/ 13737/ 13738/ 38000/ 13721/ 13722/ 13725/ 13727



These manual sausage stuffers offer a wide selection of sizes and configurations for residential and commercial applications. The standard models have enameled steel sides. All models excluding 13730 and 13735 feature a two speed gearing system - one gear for sausage stuffing and one gear to return piston quickly to starting position. All models are supplied with a selection of stuffing funnels.

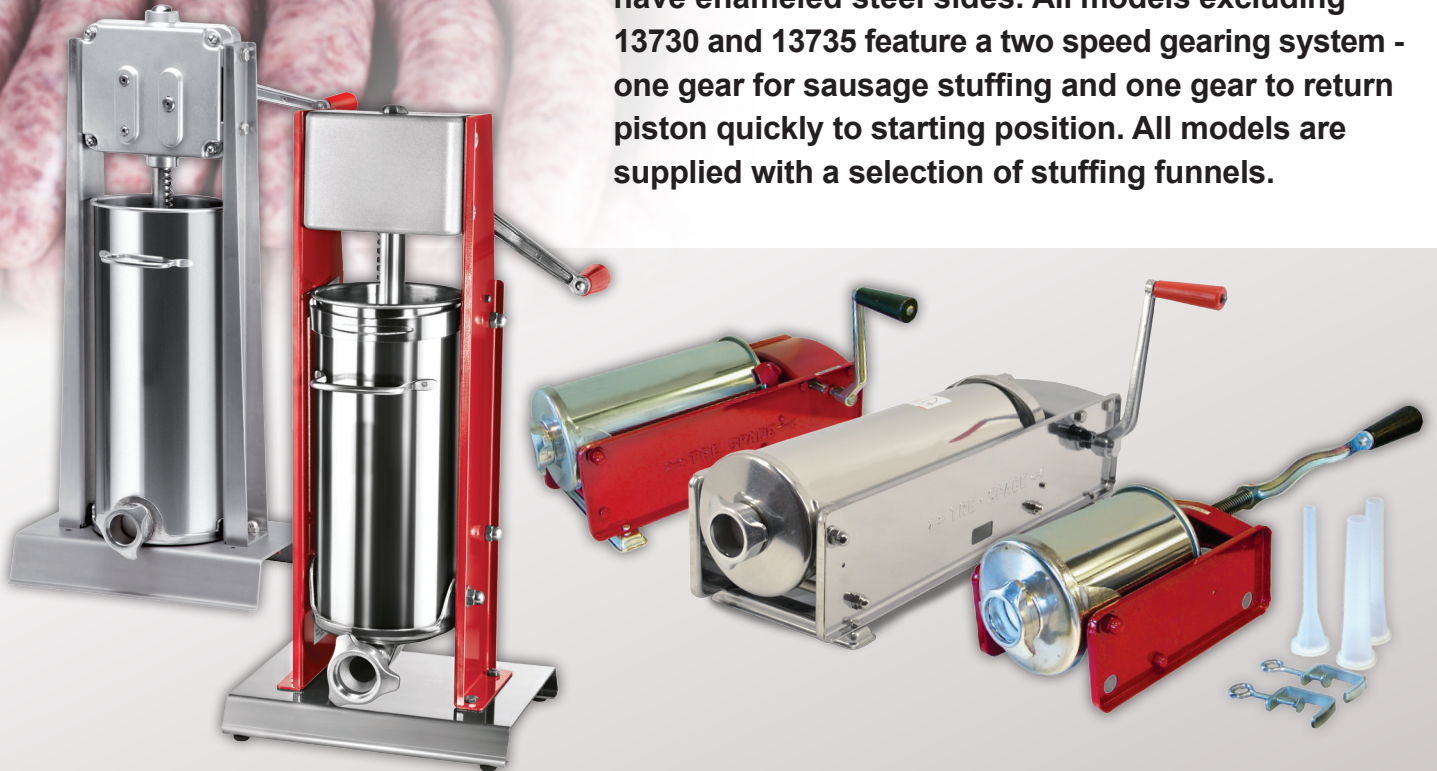

Authorized Dealer

# SAUSAGE STUFFERS

EUROPEAN SAUSAGE STUFFERS



**3 kg / 5 kg**  
capacity sausage stuffer

Item# 13730

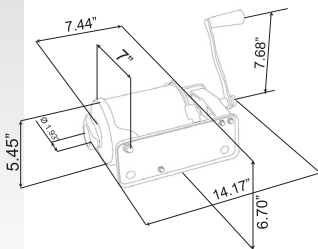

Item# 40517

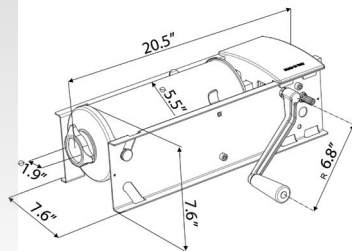

Item# 13732

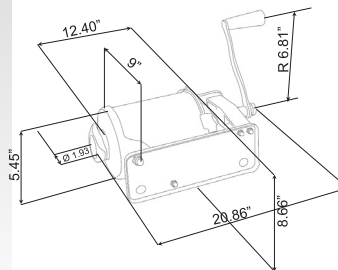

Item# 13733

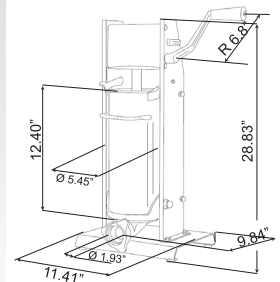

TECHNICAL SPECIFICATION	3 kg / 6 lb Capacity Horizontal Sausage Stuffer	5 kg / 11 lb Capacity Horizontal Sausage Stuffer	5 kg / 11 lb Capacity Horizontal Two-Speed Gear-Driven Sausage Stuffer	5 kg / 11 lb Capacity Vertical Two-Speed Gear-Driven Sausage Stuffer
ITEM NUMBER	13730	40517	13732	13733
TYPE	Horizontal - Direct Drive	Horizontal Two-Speed Gear-Driven	Horizontal Two-Speed Gear-Driven	Vertical Two-Speed Gear-Driven
CAPACITY	3 kg/6 lbs.	5 kg/11 lbs.	5 kg/ 11 lbs.	5 kg/11 lbs.
FUNNEL SIZES (MM)	10, 20, 30	10, 20, 30	10, 20, 30, 40	10, 20, 30, 40
WEIGHT	11 lbs.	15.4 lbs.	22 lbs.	24.25 lbs.
PACKAGING WEIGHT	12 lbs.	17.6 lbs.	23 lbs.	27 lbs.
PACKAGING DIMENSIONS	16" x 9" x 9" 40.6cm x 22.9cm x 22.9cm	21.3" x 8.7" x 8.7" 54cm x 22cm x 22cm	22" x 9" x 9" 55.9cm x 22.9cm x 22.9cm	24" x 12" x 12" 61cm x 30.5cm x 30.5cm

**OMCAN INC.**

Telephone: 1-800-465-0234

Fax: (905) 607-0234

E-mail: sales@omcan.com

Website: www.omcan.com



Follow us to keep up to date with the latest news and offers



# SAUSAGE STUFFERS

EUROPEAN SAUSAGE STUFFERS



## 7 kg

capacity sausage stuffer

Item# 13737

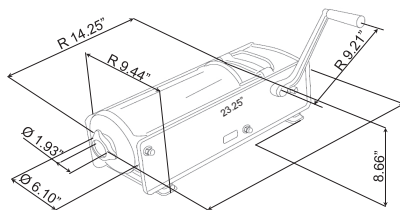

Item# 13738

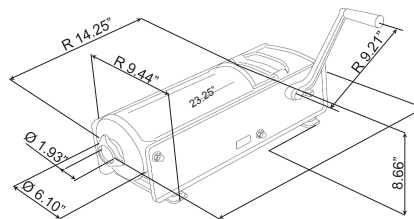

Item# 38000

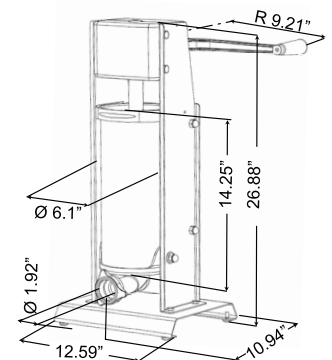

TECHNICAL SPECIFICATION	7 kg / 15 lb Capacity Horizontal Two-Speed Gear-Driven Sausage Stuffer	7 kg / 15 lb Capacity Horizontal Two-Speed Gear-Driven Sausage Stuffer - All Stainless Steel	7 kg / 15 lb Capacity Vertical Two-Speed Gear-Driven Sausage Stuffer
ITEM NUMBER	13737	13738	38000
TYPE	Horizontal Two-Speed Gear-Driven	Horizontal Two-Speed Gear-Driven	Vertical Two-Speed Gear-Driven
CAPACITY	7 kg/15 lbs.	7 kg/15 lbs.	7 kg/15 lbs.
FUNNEL SIZES (MM)	10, 20, 30, 40	10, 20, 30, 40	10, 20, 30, 40
WEIGHT	44 lbs.	34 lbs.	36.25 lbs.
PACKAGING WEIGHT	45 lbs	35 lbs	43 lbs.
PACKAGING DIMENSIONS	25" x 10" x 10" 63.5cm x 25.4cm x 25.4cm	25" x 10" x 10" 63.5cm x 25.4cm x 25.4cm	32.5" x 13.5" x 11.5" 82.6cm x 34.3cm x 29cm

## OMCAN INC.

Telephone: 1-800-465-0234  
 Fax: (905) 607-0234  
 E-mail: sales@omcan.com  
 Website: www.omcan.com



Follow us to keep up to date with the latest news and offers



# SAUSAGE STUFFERS

EUROPEAN SAUSAGE STUFFERS



## 10 kg / 15 kg

capacity sausage stuffer

Item# 13721

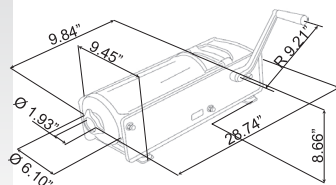

Item# 13722

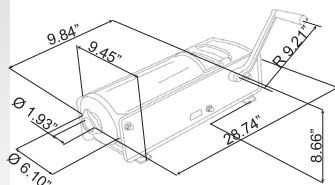

Item# 13725

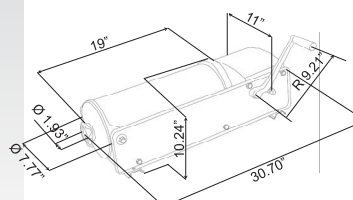

Item# 13727

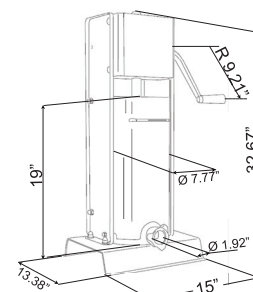

TECHNICAL SPECIFICATION	10 kg / 22 lb Capacity Horizontal Two-Speed Gear - Driven Sausage Stuffer	10 kg / 22 lb Capacity Horizontal Two-Speed Gear - Driven Sausage Stuffer	15 kg / 30 lb Capacity Horizontal Two-Speed Gear - Driven Sausage Stuffer	15 kg / 30 lb Capacity Vertical Two-Speed Gear - Driven Sausage Stuffer- All Stainless Steel
ITEM NUMBER	13721	13722	13725	13727
TYPE	Horizontal Two-Speed Gear-Driven	Horizontal, Stainless Steel sides Two-Speed Gear-Driven	Horizontal Two-Speed Gear- Driven	Vertical, Deluxe-All stainless steel-Two-Speed Gear-Driven
CAPACITY	10 kg/22 lbs.	10 kg/22 lbs.	15 kg/30 lbs.	15 kg/30 lbs.
FUNNEL SIZES (MM)	10, 20, 30, 40	10, 20, 30, 40	10, 20, 30, 40	10, 20, 30, 40
WEIGHT	40 lbs.	40 lbs.	66 lbs.	86 lbs.
PACKAGING WEIGHT	41 lbs.	41 lbs.	71 lbs.	95 lbs.
PACKAGING DIMENSIONS	30" x 15" x 17" 76cm x 38cm x 43cm	30" x 15" x 17" 76cm x 38cm x 43cm	32" x 13" x 10" 81cm x 33cm x 25.4cm	34" x 15" x 14" 86cm x 38cm x 35.6cm

### OMCAN INC.

Telephone: 1-800-465-0234

Fax: (905) 607-0234

E-mail: sales@omcan.com

Website: www.omcan.com



Follow us to keep up to date with the latest news and offers

